



S6



EN1176  
1.00m

# EN1176

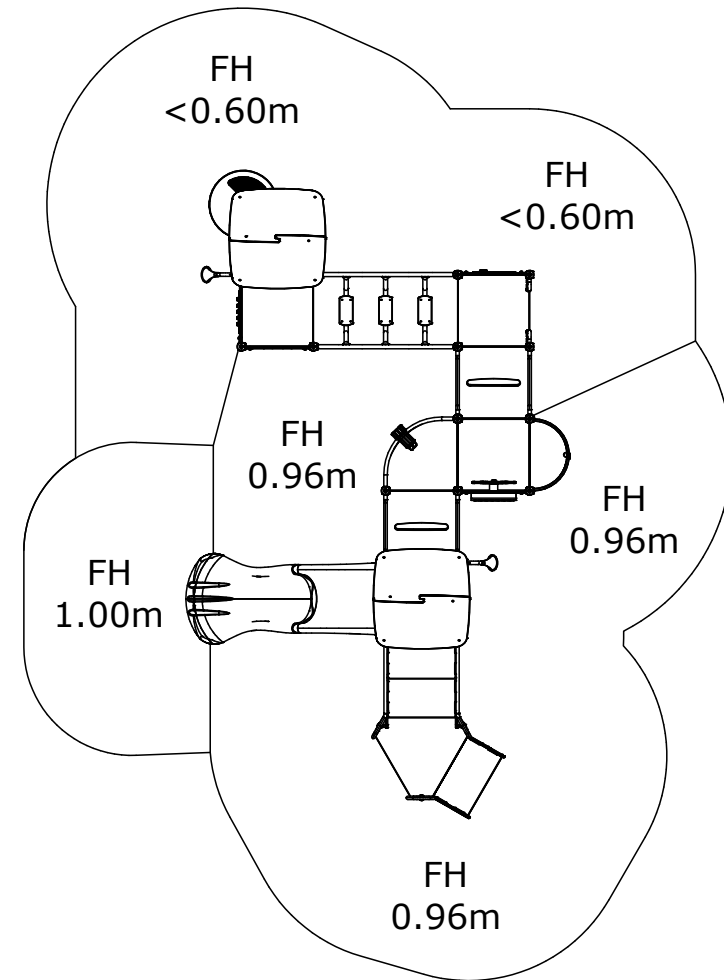
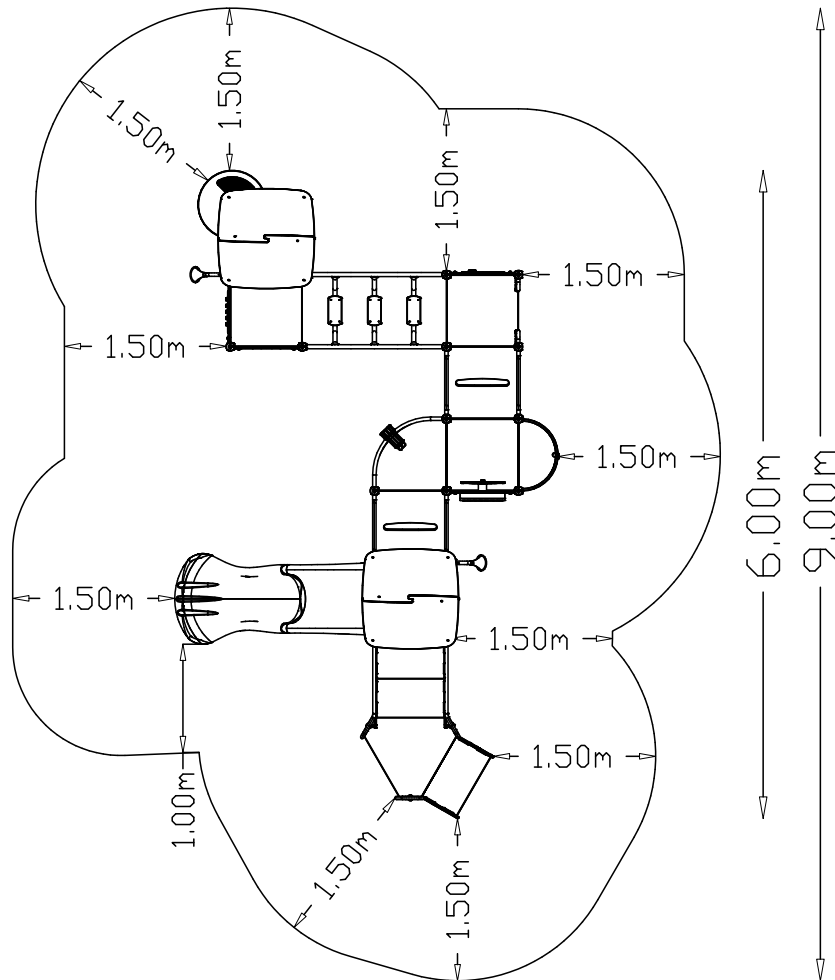
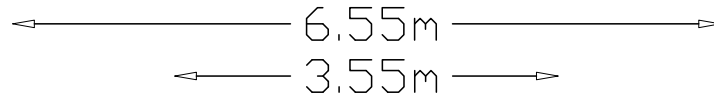

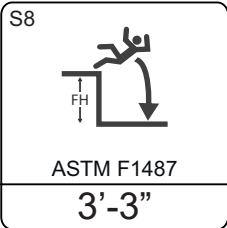

# ASTM F1487

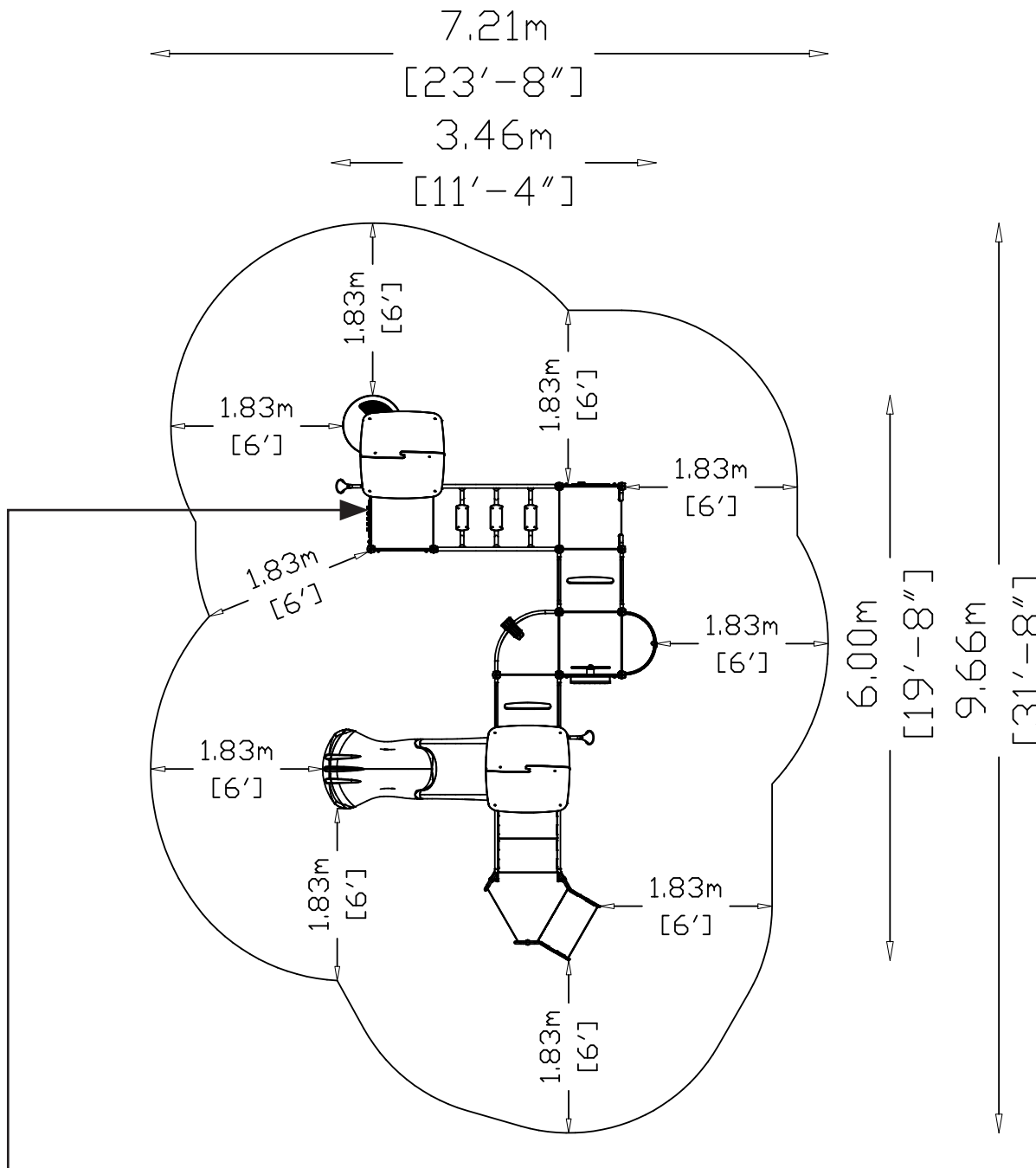

**WARNING**  
Playground equipment used for free play is not intended for use as a structure for climbing or other play activities. Do not use the equipment for activities other than those intended for its use. Do not use the equipment for activities other than those intended for its use. Do not use the equipment for activities other than those intended for its use.

**WARNING**  
Children have reported and died from injuries caught in slides and other playground equipment. Before allowing children to play, inspect for damage, loose hardware, rust, sharp edges, protrusions, and other hazards. Do not use the equipment if you find any of these hazards. Do not use the equipment if you find any of these hazards. Do not use the equipment if you find any of these hazards.

**WARNING**  
All playground equipment and rubber surfacing are subject to wear and tear. Check for hot surfaces before allowing children to play. Children should wear appropriate shoes at all times.

**WARNING**  
Playing high involves an inherent risk of injury. Playground equipment can be used to launch items from high, including, but not limited to, balls, toys, and other objects. Do not use the equipment for activities other than those intended for its use. Do not use the equipment for activities other than those intended for its use.

**play smart® rules**  
Do not play on broken or damaged equipment. Report it.  
Do not play without adequate safety supervision and trained personnel.  
No running, pushing or shoving.  
Do not play on top of equipment and do not climb on equipment.  
Watch your head. Do not run with objects, sticks, stones, or other equipment.  
Do not play on swings or any equipment that is in use.  
Do not climb on rails, bridges, or slides.  
Do not slide on rails or slides.  
Do not swing down, feet first, and over a time. Do not slide up slides or stairs.  
Do not play on top of overhead bars.  
Do not swing down with both feet.  
Do not swing down with one foot and one hand.  
Do not swing down with one hand and one foot.  
Do not swing down with one hand and one foot.  
Do not swing down with one hand and one foot.



**HAGS®**

FOR KIDS AGES  
**2-5**  
YEARS

ADULT SUPERVISION RECOMMENDED  
www.hags.com

S9

CSA Z 614  
1.00m  
[3'-3"]

# CSA Z614

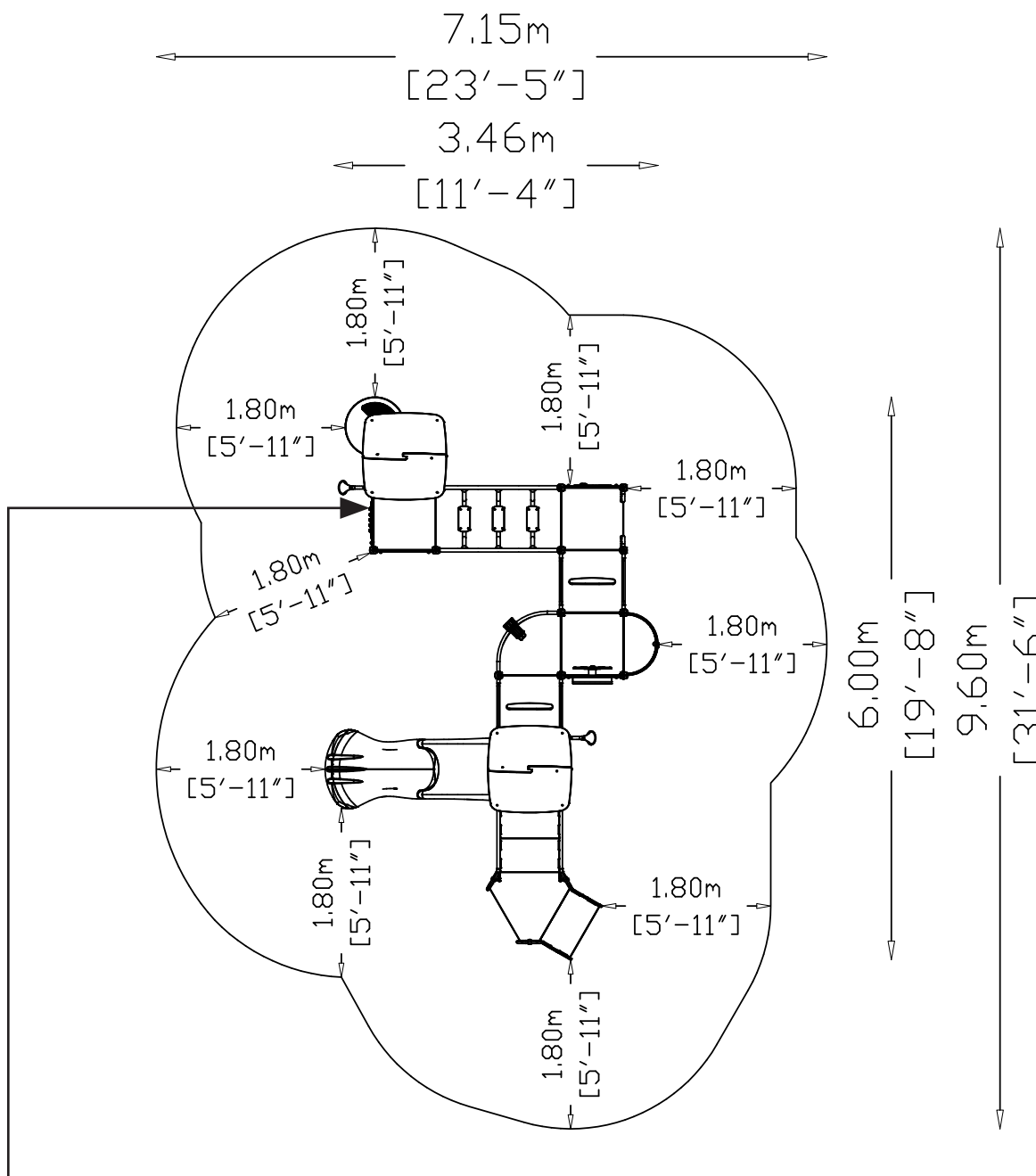

**INSTALL 101**

<p><b>WARNING</b> Playground equipment used for first activities that are intended for public use may require safety or other tests. See the manufacturer's instructions for more information on safety testing. It is essential to follow the instructions in this manual before allowing children to play.</p> <p><b>WARNING</b> Children are required to use the same surface caught on slides and other playground equipment. Before allowing children to play, verify that the surface is suitable for the intended use. Also, verify the proper use, storage, or other items that are associated with the slides. Also, verify the proper use, storage, or other items that are associated with the slides.</p> <p><b>WARNING</b> All playground equipment and rubber surfacing must be installed in accordance with the manufacturer's instructions. Check for hot surfaces before allowing children to play. Children should wear appropriate shoes at all times.</p> <p><b>WARNING</b> Playground equipment on an uneven playground surface can lead to serious injury from falls, collisions, and head strikes. Do not use playground equipment on uneven surfaces. The manufacturer's instructions should be followed.</p>	<p><b>play smart! rules</b></p> <ul style="list-style-type: none"> <li>Do not play on broken or damaged equipment. Report it.</li> <li>Do not play without adequate safety training and proper equipment.</li> <li>No running, pushing or shoving. If the center of the play surface and equipment are not visible, do not play.</li> <li>Do not play on or run on playground equipment and its structure if it is damaged.</li> <li>Watch your head! Do not run, climb, swing, slide, or use other equipment.</li> <li>Do not play on swings or any equipment if the seats or on top of seat through hole.</li> <li>Do not swing down, feet first, and over a time. Do not slide up slides or ladders.</li> <li>Adults - do not slide with a child on your lap. Do not ignore your child's help.</li> <li>Before letting go of overhead bars, hand grips with hand your hands a little and drop straight down with both feet.</li> <li>Always swing down and do not jump or slide sideways. Do not touch other children while playing and be careful.</li> </ul>
---	---

**INSTALL 101**

**HAGS®**

FOR KIDS AGES

**18-5**  
MONTHS YEARS

ADULT SUPERVISION RECOMMENDED  
www.hags.com

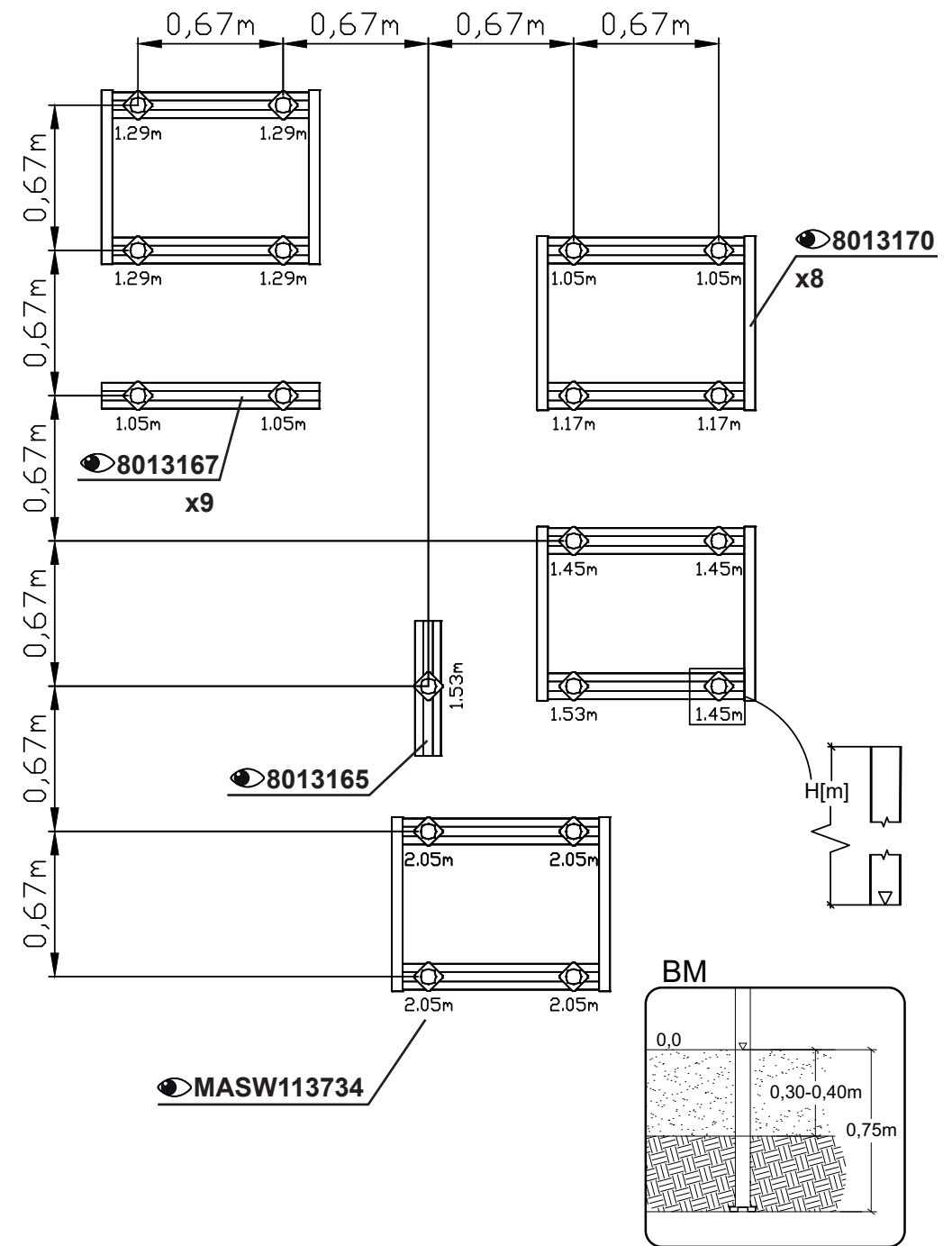
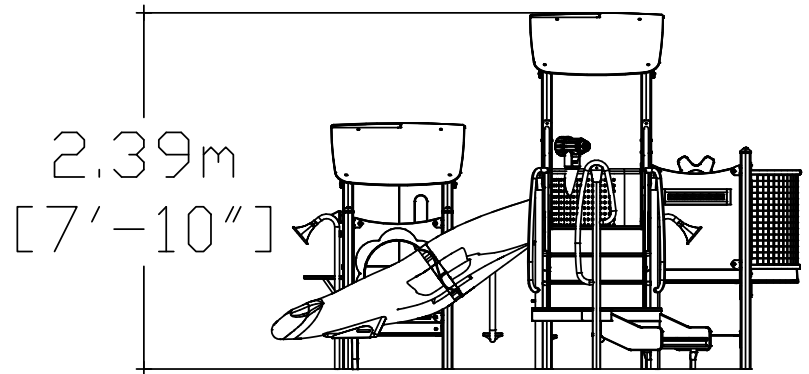
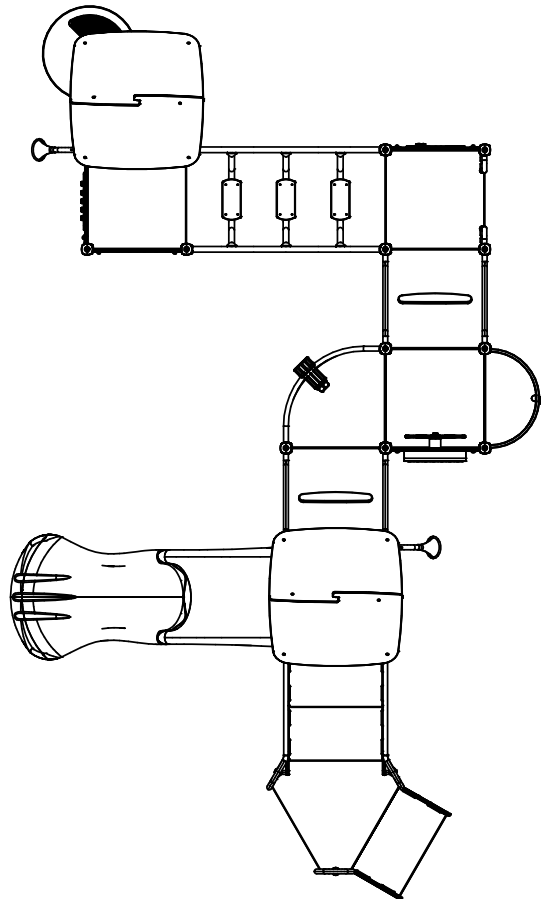

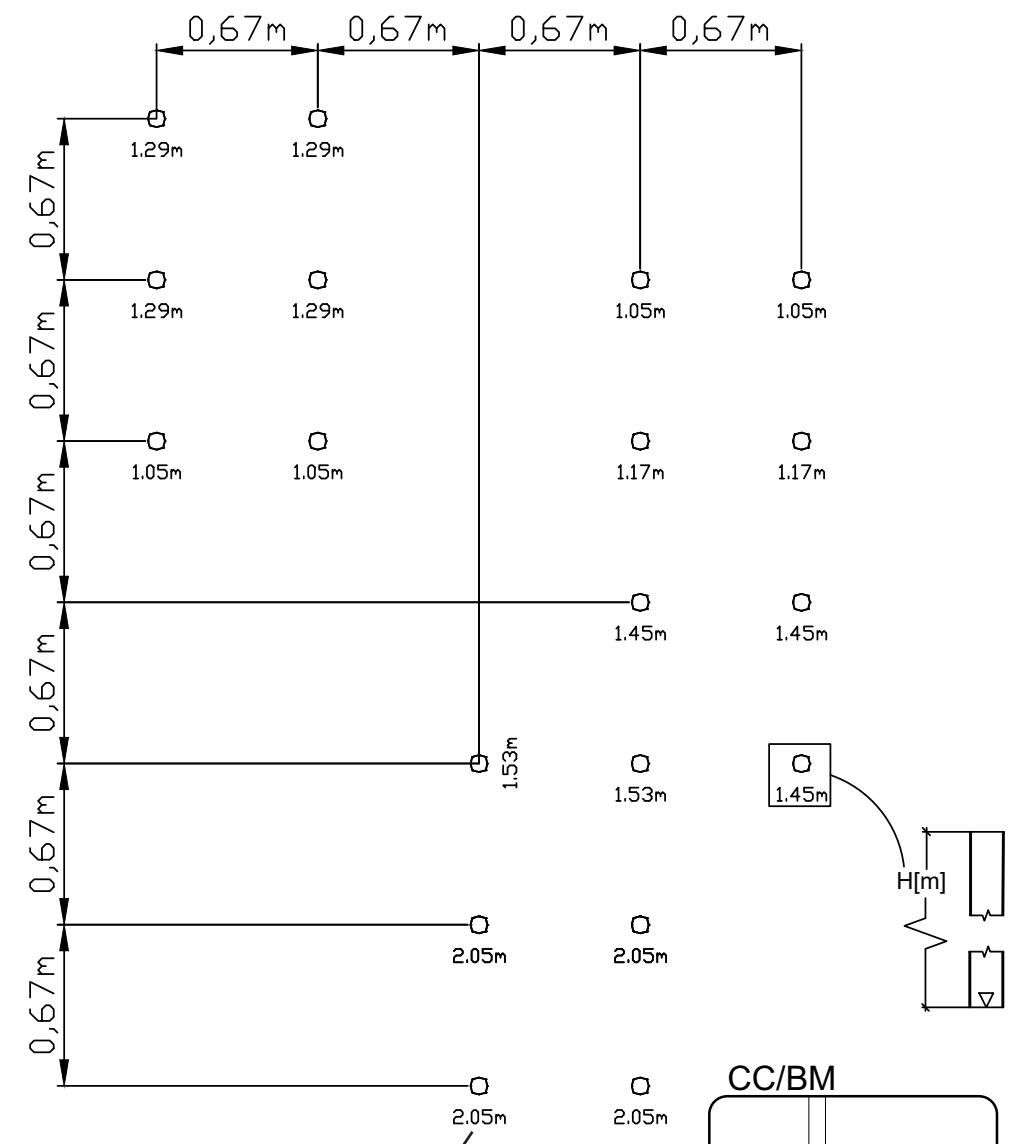
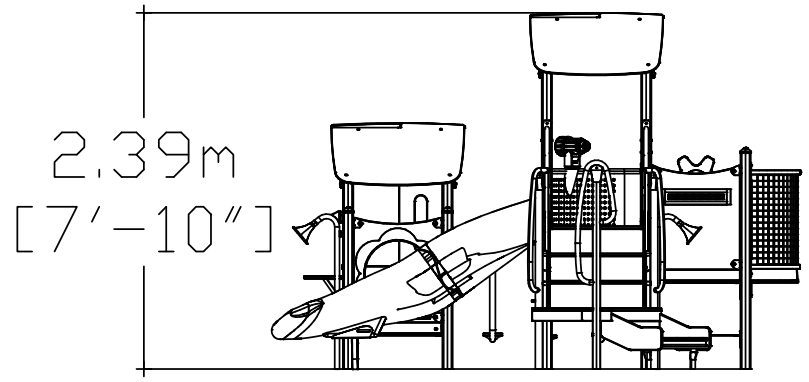
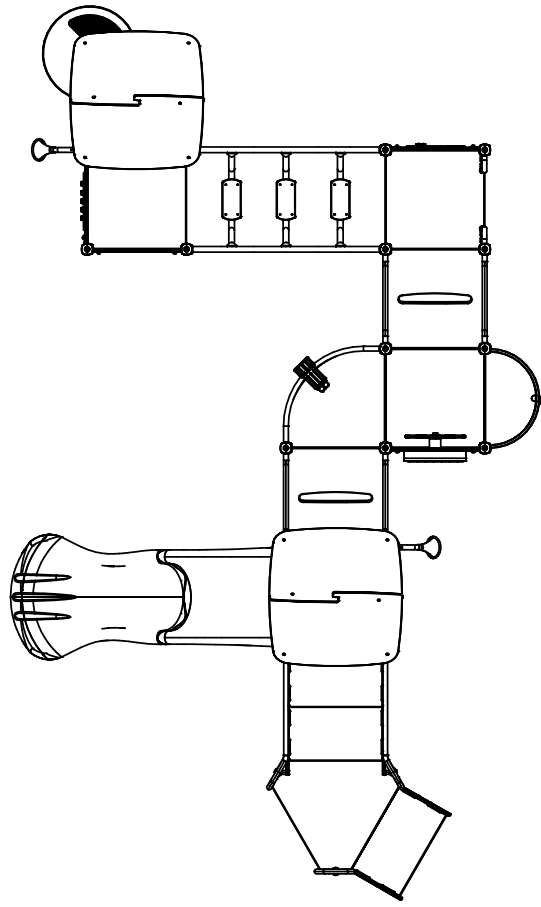

MASW113734

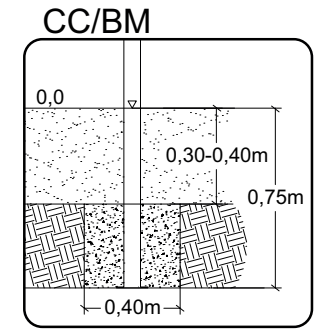

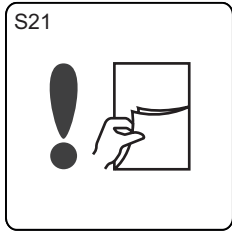

**Install 101**  
**6942**  
**6952**  
**6954**  
**6965**  
**260329**  
**620995**  
**650099**  
**693812**  
**45091210**  
**MA612313\_ST**  
**MA624U675321**  
**MAST6101**  
**MAST6932**  
**MASTOM675321**  
**MASW113734**  
**MASW35156**  
**MASW39314**  
**MAUSW117643**  
**MAUSW117644**  
**ST 6712 -061207**  
**ST 6844**

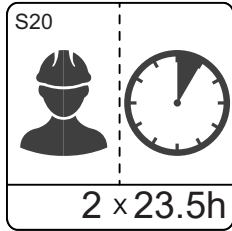

**ST621101**  
**ST621301**  
**ST641307**  
**ST641407**  
**ST6762**  
**ST695105**

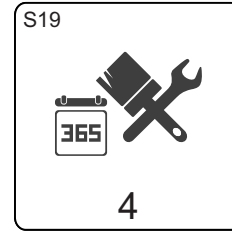
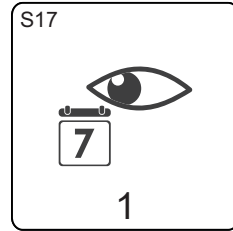

**MASW113734**

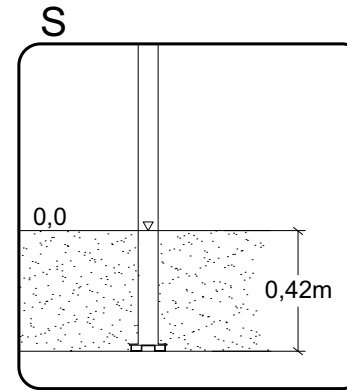

**S**  
**Sunken Foundation**

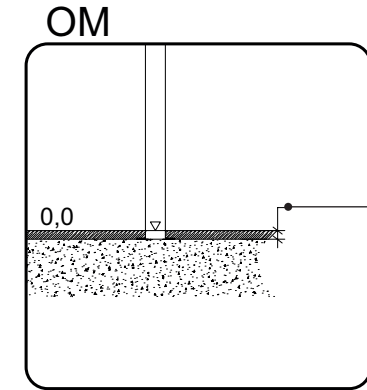

**OM**  
**Above Ground**

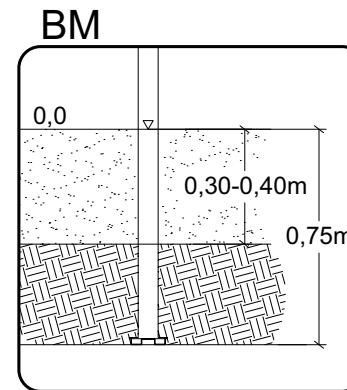
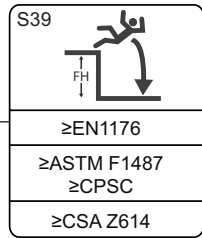

**BM**  
**Loosefill**  
 8112115

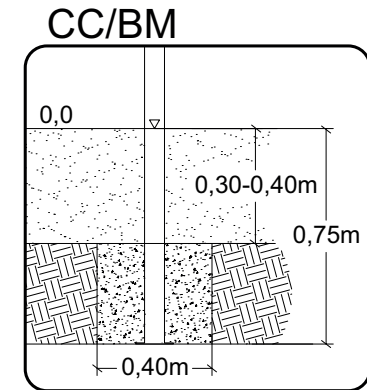

**CC/BM**  
**Cast Loosefill**  
 8112115

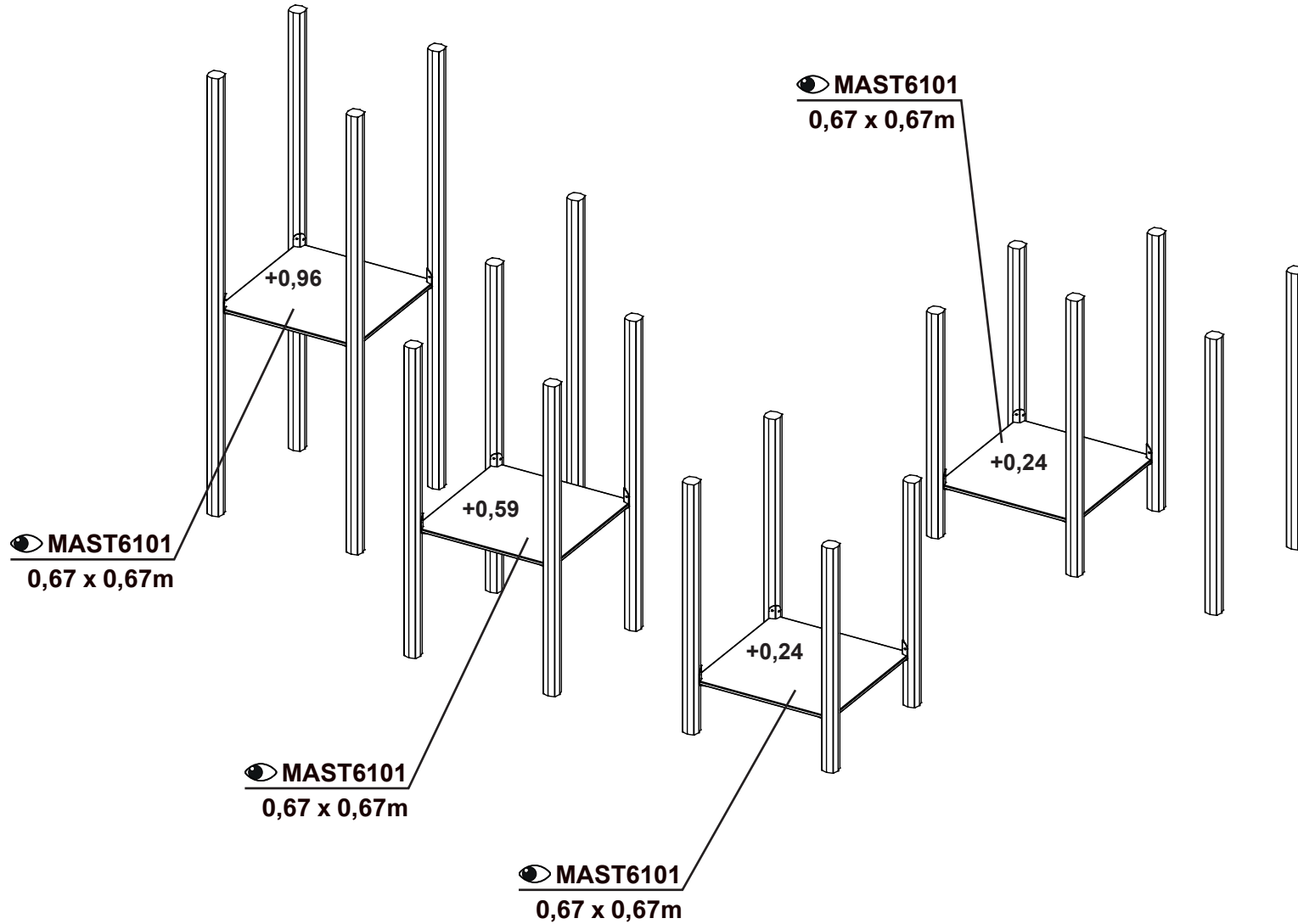
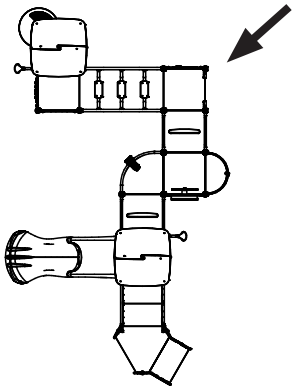



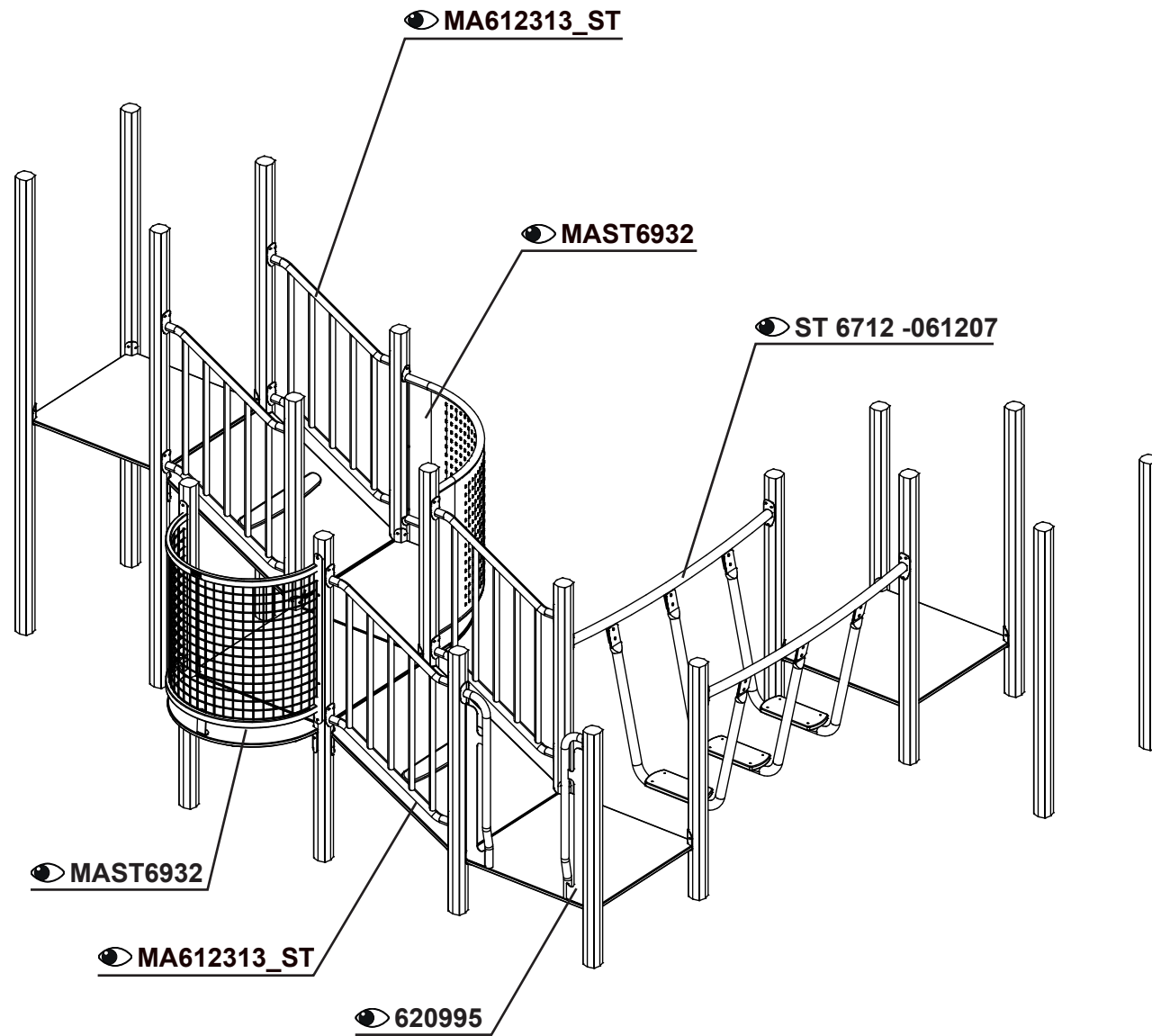
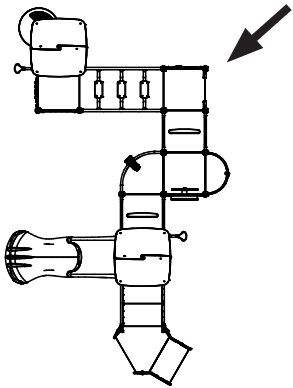

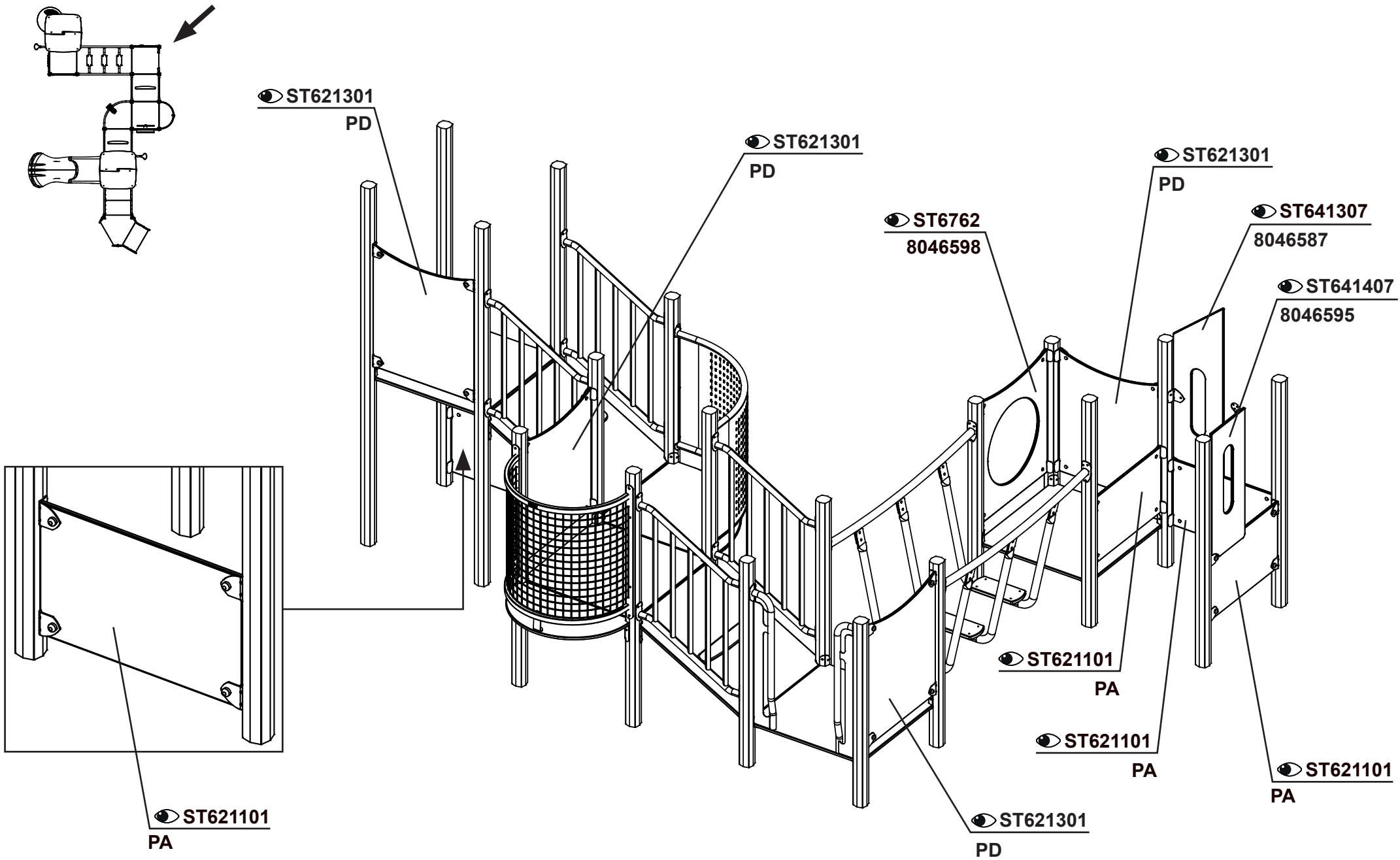

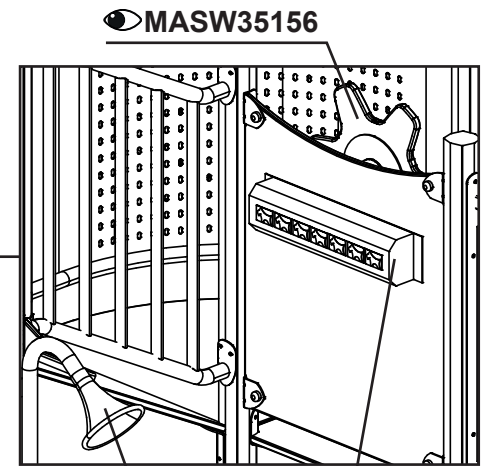
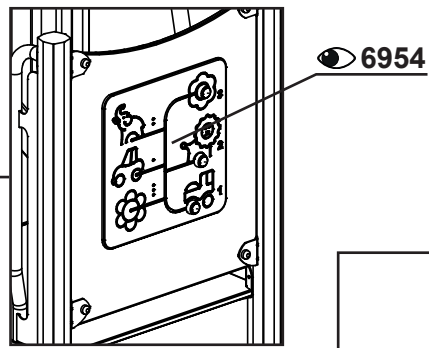
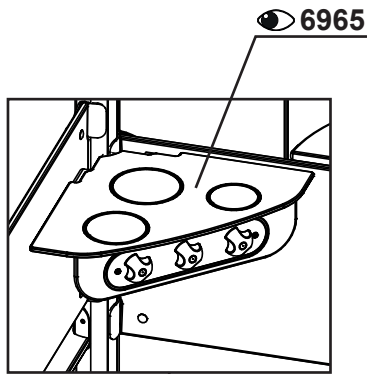
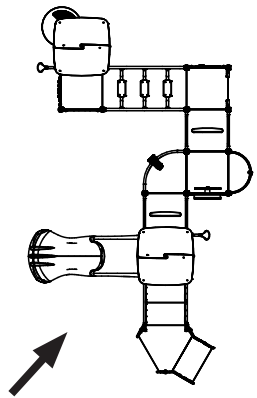

45091210

6942

ST 6844

45091210

6952

693812

ST695105

MA624U675321 [BM]

MASTOM675321 [OM]

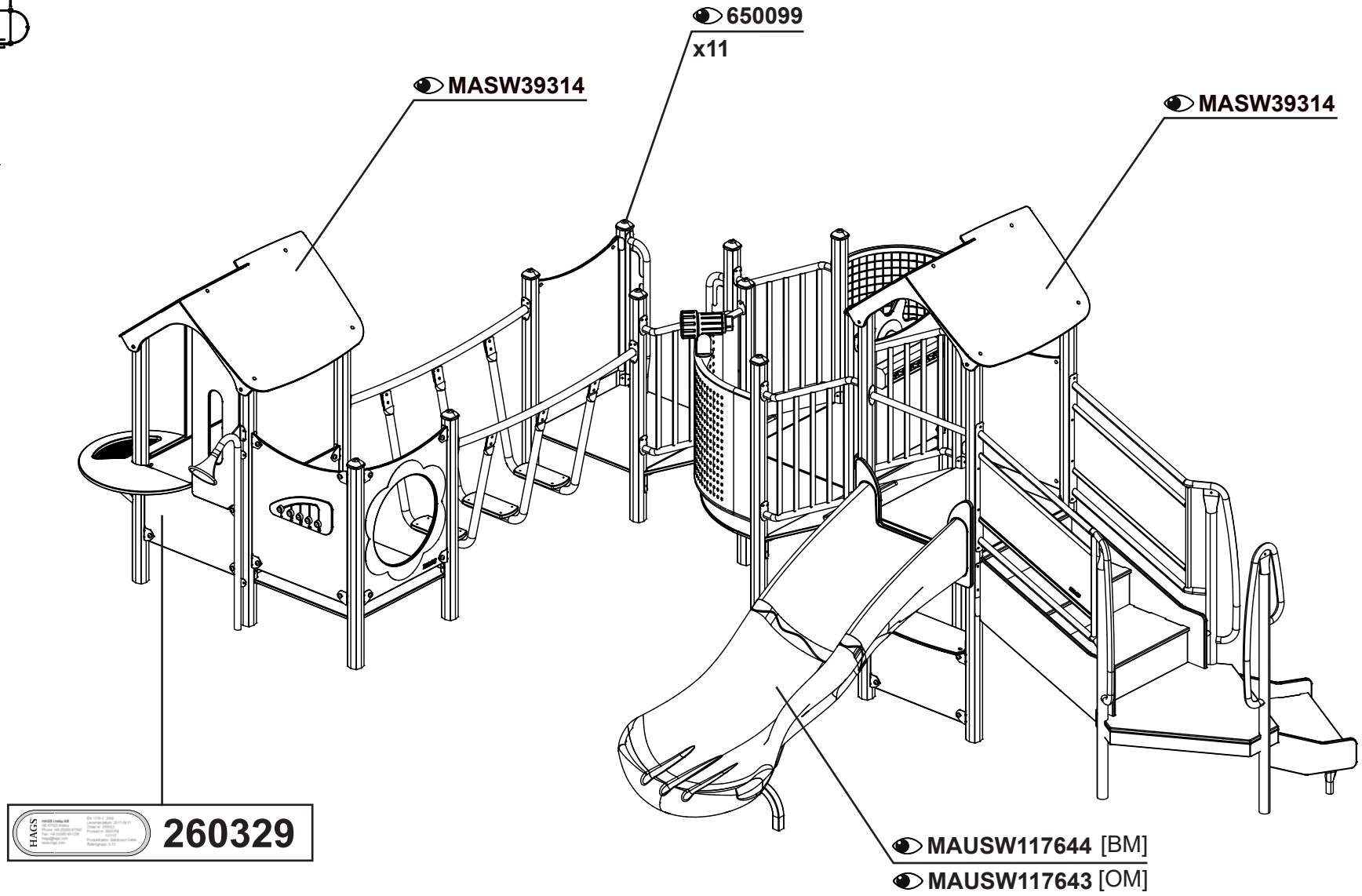
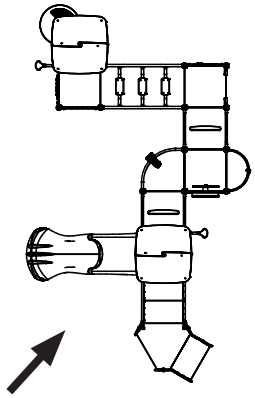

HAGS  
 260329